

EDSTROM Cooling Systems for Swine



DRIP-COOL SYSTEM



SPRAY-COOL SYSTEM

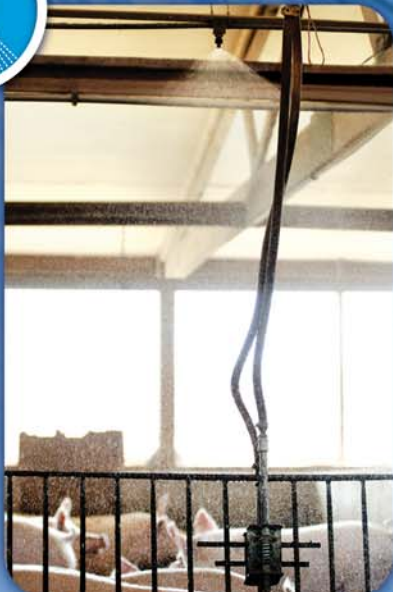

Heat Stress... Condition Critical?

The extremely competitive hog market demands that producers take advantage of every beneficial tool available to stay profitable. Stress of any kind can be extremely detrimental to profitable production. Heat stress, in particular, can be a major cause of financial loss. Poor feed conversion, reduced feed intake, lower conception rates, early embryonic deaths, and even deaths of mature animals can result from too much heat stress. EDSTROM Industries is committed to providing cost effective solutions to this major industry wide problem.

Research has shown that sows, boars and finishing pigs begin to feel the negative effects of heat stress at about 20°C (68°F). As temperatures and humidity levels rise throughout the summer months, the resulting decrease in performance can result in tremendous economic loss for the producer (*see the Heat Stress chart on the following page which shows the critical temperature and humidity levels for swine*). Swine are impacted in many ways by the stress caused by hot weather. Some of these are very visible and measurable, while other hidden complications may not be realized until weeks or even months have passed.

The main effects of heat stress in growing and finishing pigs include decreased feed intake and reduced feed efficiencies. As performance slips, so do profits. Delays in marketings can cause bottlenecks in production scheduling. Hogs that are sent to market at lighter weights in order to free up pen space receive a lower price, which compounds the impact to your bottom line.

Heat stress in boars will result in decreased sperm production and quality. The impact is long lasting, since it takes four to six weeks for the development and maturation of new sperm. This

Table 1
Optimum Temperatures for Housed Swine of All Ages

Animal	Optimum Temp. (°F)	Desirable Range (°F)
Litter – Newborn	95	90 to 100
Piglets (4 to 12 lbs.)	85	80 to 90
Pigs (12 to 45 lbs.)	80	75 to 85
Growing (45 to 120 lbs.)	70	60 to 80
Finishing (120 to 260 lbs.)	65	50 to 75
Gestating Sows	65	50 to 80
Lactating Sows	65	55 to 80
Boars	65	50 to 80

Doc. AN107 (2001) Florida Cooperative Extension Service, Robert Myer & Ray Bucklin

can cause major setbacks in breeding schedules and prevent efficient use of facilities as stocking rates fluctuate throughout the year.

In the sow, the impact of heat stress can be devastating. Temperatures above 27°C (80°F) will delay or even prevent the occurrence of estrous, reduce conception rates, and increase early embryonic death. Heat stress during the first 2 weeks post mating can reduce embryonic survival by 30% to 40%. Heat stress during the last few weeks prior to farrowing can result in reduced litter weights and a higher number of stillbirths. In lactating sows, heat stress will result in reduced feed intakes, lower milk production and increased weight loss.

Overall, minimizing the impact of heat stress can be one of the most important and economical management strategies that you undertake (*Table 1 shows the optimum temperature for swine at different stages of production*). EDSTROM Industries provides the necessary tools to help you manage this stress and help you maintain the production efficiencies that you need to remain competitive in today's markets.

Producers have long recognized the need to reduce heat stress. EDSTROM Industries (E.I.) was a leader in developing an innovative automated cooling system to meet these needs, and continues to be a leader in easy-to-use, cost effective, Drip-Cool and Spray-Cool Systems.

Other cooling systems exist, but the EDSTROM Spray-Cool and Drip-Cool systems remain the most popular due to the simplicity of operation, reliability of performance, maintenance free operation and low initial cost.

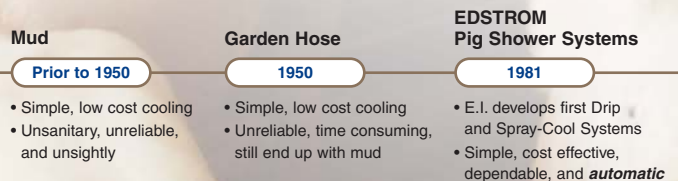

Beat the Heat with EDSTROM Controllers

“The Smart Mode™ allows producers to increase soaking frequency as temperatures increase and reduces the volume of water used. The EDSTROM C-440S with Smart Mode takes the guess work out of programming the Controller. Once the LO and HI Range settings are determined, Smart Mode does the fine-tuning so the producer doesn’t have to. The EDSTROM C-440S is the only Controller on the market that will do this.”

– Dr. John F. Smith, KSU Extension Dairy Specialist

EDSTROM offers all the major components needed to economically set up an intermittent showering system in your facility, including soaker nozzles, electric valves, filters, pressure reducers and the heart of the system – The Controller. The EDSTROM C-440S Controller permits control of up to four electric solenoid valves activated in sequence. This helps reduce the amount of water required at one time by splitting a barn into multiple zones. The electronic Controller allows the user to program the thermostat and time settings. Its Smart Mode™ setting automatically adjusts the length of time between shower cycles (Interval Time) as the temperature changes.

Smart Mode was added after work with dairy cattle at Kansas State University showed a benefit to having at least three different shower time settings as temperatures increased. This feature is just as beneficial in the swine industry, as it reduces wasted water at lower temperatures while keeping ahead of heat stress as temperatures increase. The new C-440S Controller also has the ability to monitor up to four separate temperature sensors, so that multiple rooms can be cooled with a single Controller.

Heat Stress
Temperature and Humidity Stress Index for Growing-Finishing Swine



C-440S Controller with Smart Mode™ for Automated, Multiple Stage Cooling

Programming of the C-440S Controller is easy to do. Time and temperature settings in both LO Range and HI Range are easily viewed and adjustable. The shower and interval times can be set anywhere within the range of 0 to 99 minutes. The actuation temperature can be set within 40°F to 99°F in either the LO or HI Range settings. You can also select the number of electric solenoid valves to be operated, as well as the number of temperature sensors that will be monitored. The Controller can be easily toggled to operate in either standard Two-Stage mode or in Smart Mode. Once the settings are entered, they are saved automatically, and will not be lost if the electrical power is interrupted.

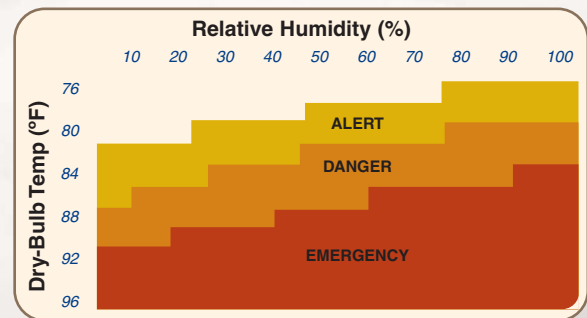

EDSTROM
Micro-Cool Single
Stage Controllers

1985

EDSTROM
Micro-Cool 2
Stage Controllers

1994

EDSTROM
Micro-Cool
Sequencer 4

1995

- 24 volt for added safety
- Control up to 4 zones in sequence to reduce water demand

EDSTROM
C-100/C-400
Controllers

1996

EDSTROM
C-110S/C-440S
Controllers

2004

- **Smart Mode** technology
- Ability to monitor multiple temperature sensors

Typical Installation for Swine Cooling

Normal recommendations are to wet the animals for a short period of time, 0.5 to 3.0 minutes, to wet the skin. After the Shower or Dripper shuts off, the water is evaporated from the pigs by the normal ventilation system in the facility. The evaporation (Interval Time) cycle is normally set for a period of 5.0 to 10.0 minutes, before the wetting cycle is repeated.

Spray-Cool Systems are designed for use in swine finishing units or group gestation buildings, where the animal has the opportunity to get showered if desired. A Drip-Cool System is used in a farrowing room or crated gestation facilities, where it is important to direct the water onto the individual sow while avoiding excess moisture in the surrounding area.



1. Location of Spray-Cool Shower Nozzles

The Shower Nozzle should be located in the dunging area with attention paid to feeder location. It is best for coverage to reach from sidewall to sidewall in each pen. The height of the nozzle will determine the coverage area.

2. Location of Drip-Cool Nozzles

The individual Drip Nozzle or Mister Nozzle should be located to direct the water onto the front shoulder area of the sow (see photo above). Each nozzle should be secured so that it does not move and can not be reached by the animal. The Mister Nozzle should be positioned to cover as much of the sow as possible from the neck area back.

3. Plumbing Arrangement

The plumbing arrangement will depend on the quantity and type of nozzles being installed, as well as the water flow capacity of your facility. Multiply the number of nozzles by the nozzles' rated capacity to obtain the total water flow-rate required for the facility.

For Spray-Cool Systems, select the system based on the size of your facility, the total number of Spray Nozzles you will be operating, and the number of Electric Valves you need to use.

An Electric Valve/Filter Assembly can normally supply up to 20 Spray Nozzles, as explained in the following guidelines. The C-110S Controller operates a single Electric Valve.

If your facility requires more than 20 nozzles, you will want to divide the plumbing into zones of 20 nozzles or less, each served by an individual Electric Valve/Filter Assembly. The C-440S Controller must be used to operate multiple Electric Valves; it will actuate them in sequence, thereby reducing the momentary water demand.

For Drip-Cool systems, up to 480 Drip Nozzles can be supplied by a single Electric Valve/Filter/Pressure Reducer Assembly. Keep the length of the Distribution Lines as short as possible. The maximum recommended length of branch Distribution Line is 100 feet from the Electric Valve/Filter/Pressure Reducer Assembly to the end of the line. In large facilities requiring multiple branches of Distribution Lines, mount the Electric Valve/Filter/Pressure Reducer Assembly centrally and branch out from it. All Distribution Lines in a system should be level and installed at equal heights.

4. Location for the Controller

The EDSTROM Controller should be located where it will be easy for the operator to view and make program adjustments.



Drip-Cool System

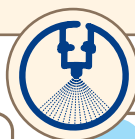
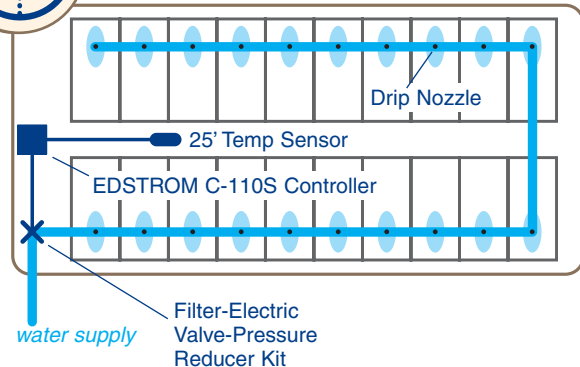

Spray-Cool System

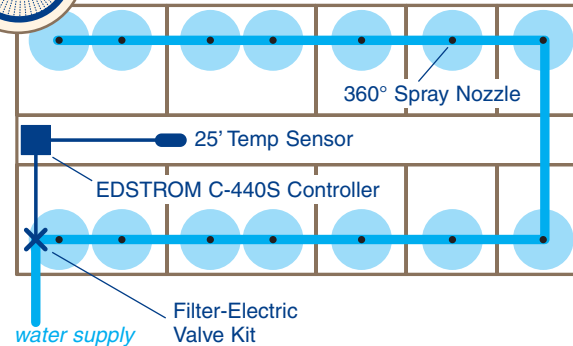



C-110S Controller
7400-8910-015 (110VAC/24VAC)
7400-8910-215 (24VAC)

Two-Stage programmability with optional Smart Mode operates a single electric valve, 24VAC. Use in most drip-cool, smaller spray-cool systems where a single cooling zone is adequate.



C-440S Controller
7400-8940-015 (110VAC/24VAC)
7400-8940-215 (24VAC)

Two-Stage programmability with optional Smart Mode operates from one to four electric valves, 24VAC in sequence. Use in larger applications where it is desirable to split the entire area to be cooled into smaller zones to reduce water demands. One to four temperature sensor cables can be connected.

Complete Systems:

- 7400-5240-110** C-110S Spray-Cool System: Includes C-110S Controller, 1 Electric (24VAC) Valve and Filter Assembly, 50 ft. Wire, 8 Spray Nozzles, 100 ft. Tubing and all Hardware
- 7400-5240-440** C-440S Spray-Cool System: Includes C-440S Controller, 1 Electric (24VAC) Valve and Filter Assembly, 50 ft. Wire, 8 Spray Nozzles, 100 ft. Tubing and all Hardware
- 7400-5250-115** Drip-Cool System: Includes C-110S Controller, 1 Electric (24 VAC) Valve and Filter Assembly, 50 ft. Wire, 20 Drip Nozzles with Anti-Drip Check Valves, 100 ft. Tubing, Pressure Reducer and all Mounting Hardware

Add-On Kits:

- 7400-5245** Spray-Cool Add-On Kit: Includes 6 Spray Nozzles, 100 ft. Tubing and all Hardware
- 7400-5255-005** Drip-Cool Add-On Kit: Includes 20 Drip Nozzles with Anti-Drip Check Valves, 100 ft. Tubing and all Hardware

Electric Valve Kits:

- 7400-8945-100** Electric Valve/Filter Kit for Rigid Pipe Installation: 24 VAC, 3/4 in. PVC Pipe Connections, 150 Mesh Filter, 50 ft. Wire
- 7400-8945-140** Electric Valve/Filter Kit for Spray-Cool: 24 VAC, GHT Fittings, 150 Mesh Filter, 50 ft. Wire
- 7400-8945-150** Electric Valve/Filter/Pressure Reducer Kit for Drip Cool: 24 VAC, GHT Fittings, 150 Mesh Filter, 15 psi Pressure Reducer, 50 ft. Wire

Miscellaneous Components:

- 2320-3145-050** Spray Nozzle Tee Assembly with 0.5 gpm tip (standard spray nozzle)
- 2320-4298-550** Spray-Cool Nozzle Check Valve, 2 psi cracking pressure/ 50 micron screen, plastic
- 2320-4491-110B** Drip Nozzle, 1 gph, cleanable, 5/32 in. barb (bag of 20)
- 2320-4927-100** Mister Nozzle, 3 ft. dia. pattern, 5 gph, for gestation crates
- 2030-6270-100** Drip-Cool Check Valve, 2 to 5 psi cracking pressure, 5/32 in. barb x 5/32 in. barb
- 1600-3304-100** 1/2 in. ID Blue-Poly Tubing (100 ft. roll)
- 1600-4498-100** 5/32 in. ID Black-Poly Tubing (100 ft. roll)

**For a complete listing, contact EDSTROM Industries or visit our online store at: www.agselect.com*

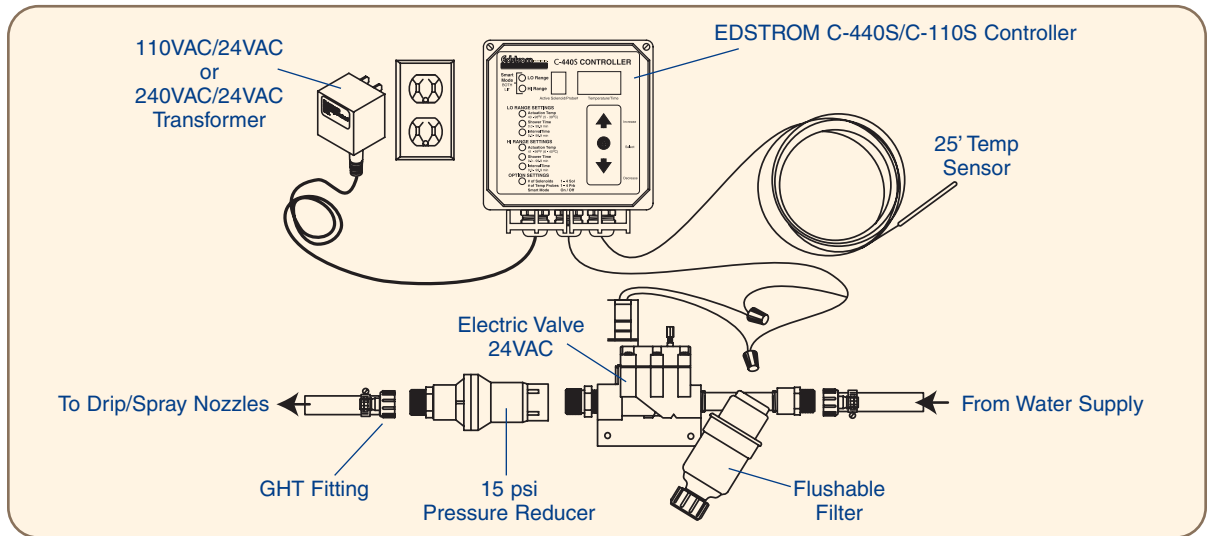



- Easy to Use
- Proven Reliability
- Economical to Install and Operate
- User Programmable Controllers

"In 2005 we tested the EDSTROM C-440S Controller in the gestation rooms of some of our sow farms. We found that through the ability of the EDSTROM Controller, with Smart Mode, to sequence through four zones and the use of check valves in the spray lines, we were able to dramatically reduce water usage. Our sows showed no loss in production. We will increase the number of farms that have the EDSTROM C-440S Controller."

*– Greg Wulf
Murphy Family Ventures, LLC
Senior Production Manager*

Contact us to find a dealer near you:

service@agselect.com

www.agselect.com

Edstrom INDUSTRIES, INC.

819 Bakke Avenue • Waterford • Wisconsin 53185
Tel: 262 534 5181 • 800 558 5913 • Fax: 262 534 5184